

FOB-2W-4B

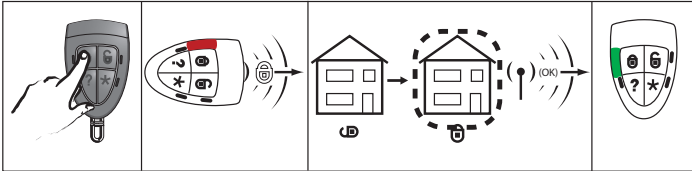

COOPER Security

OK TO SET, **NL** INSCHAKELEN, **FR** MISE EN SERVICE, **IT** PER INSERIRE IN MODO TOTALE



OK PART SET, **NL** GEDEELTELIJK INSCHAKELEN, **FR** MISE EN SERVICE PARTIELLE, **IT** PER INSERIRE IN MODO PARZIALE

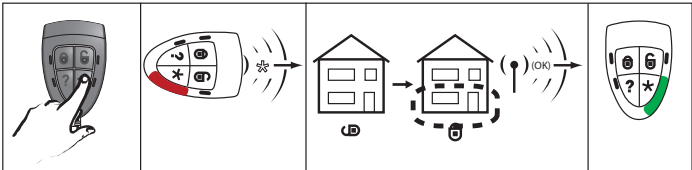

OK SETTING FAILED, **NL** INSCHAKELFOUTEN, **FR** ECHEC DE MISE EN SERVICE, **IT** INSERIMENTO FALLITO

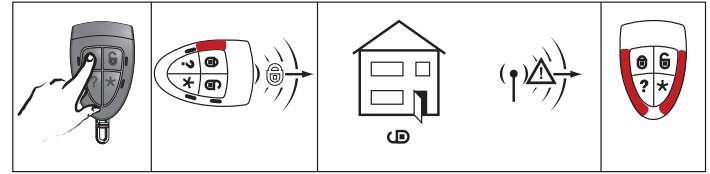

OK TO UNSET, **NL** UITSCHAKELEN, **FR** MISE HORS SERVICE, **IT** PER DISINSERIRE

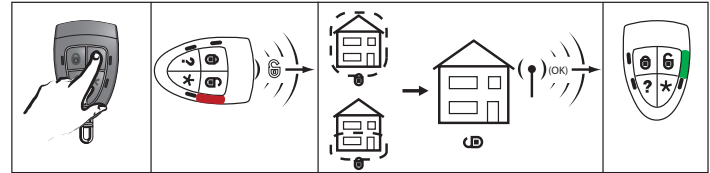

OK TO UNSET AFTER AN ALARM, **NL** UITSCHAKELEN NA EEN ALARM, **FR** MISE HORS SERVICE APRÈS UNE ALARME, **IT** PER DISINSERIRE DOPO UN ALLARME

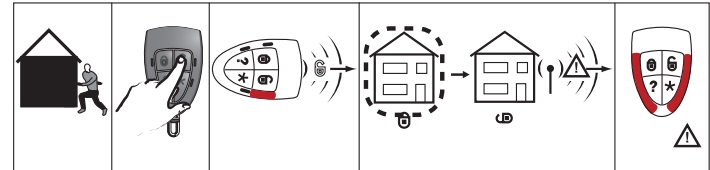

UK QUERY, **NL** VRAAG, **FR** INTERROGATION, **IT** INTERROGAZIONE

UK Full Set, **NL** Volledig Inschakelen, **FR** Marche Totale, **IT** Inserito Totale

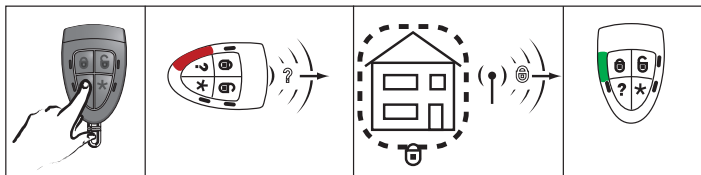

UK Part Set, **NL** Gedeeltelijk Inschakelen, **FR** Marche Partielle, **IT** Inserito Parziale

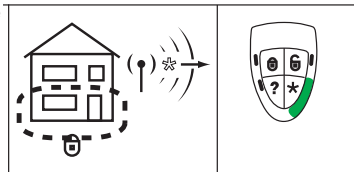

UK Unset, **NL** Uitschakelen, **FR** Arrêt, **IT** Disinserito

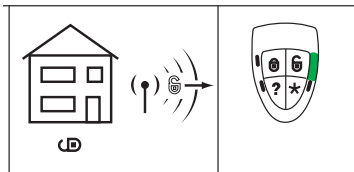

UK TO START A HOLD UP ALARM, **NL** OVERVAL MELDEN, **FR** APPEL D'URGENCE / AGRESSION, **IT** PER INVIARE UNA CHIAMATA DI ALLARME



UK Enabled, **NL** Geactiveerd, **FR** Activé, **IT** Abilitato

UK TO CHANGE THE BATTERY, **NL** DE BATTERIJ TE VERVANGEN, **FR** CHANGEMENT DE LA PILE, **IT** PER SOSTITUIRE LA BATTERIA

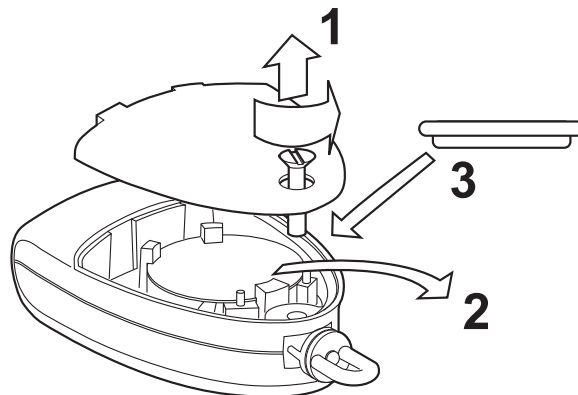

© Cooper Security Ltd. 2011

IN NO EVENT WILL COOPER BE LIABLE FOR ANY SPECIAL, CONSEQUENTIAL, OR INDIRECT LOSS OR DAMAGE, INCIDENTAL DAMAGES, STATUTORY DAMAGES, EXEMPLARY DAMAGES, LOSS OF PROFITS, LOSS OF REVENUE, LOSS OF ANTICIPATED SAVINGS, LOSS OF BUSINESS OR OPPORTUNITY, LOSS OF GOODWILL OR INJURY TO REPUTATION, LIQUIDATED DAMAGES OR LOSS OF USE, EVEN IF INFORMED OF THE POSSIBILITY OF SUCH DAMAGES. COOPER'S LIABILITY FOR DAMAGES ARISING OUT OF OR RELATED TO A PRODUCT SHALL IN NO CASE EXCEED THE PURCHASE PRICE OF THE PRODUCT FROM WHICH THE CLAIM ARISES. TO THE EXTENT PERMITTED BY APPLICABLE LAW, THESE LIMITATIONS AND EXCLUSIONS WILL APPLY WHETHER COOPER'S LIABILITY ARISES FROM BREACH OF CONTRACT, BREACH OF WARRANTY, TORT (INCLUDING BUT NOT LIMITED TO NEGLIGENCE), STRICT LIABILITY, BY OPERATION OF LAW, OR OTHERWISE.

Every effort has been made to ensure that the contents of this book are correct. The contents of this book are subject to change without notice.

Printed and published in the U.K

For more information please visit www.coopersecurity.co.uk and search for "FOB-2W-4B". Alternatively, try the QR code at the right.

Part number: 12111382

